

LED High Bay



Product Spec:

| Product Code | Dimension D*H[mm] | Power [W] | Input Voltage [V] | Efficiency [lm/W] | Color Temp[K] | CRI | Beam Angle | UGR | LED Chip |
|---------------|-------------------|-----------|-------------------|-------------------|---------------|-----|------------|--------|--------------|
| AL-HB04R-100W | Φ300*146mm | 100W | AC100-277V | 120-130lm/W | 4000K-5000K | ≥80 | 60°90°120° | UGR<25 | Lumileds3030 |
| AL-HB04R-150W | Φ300*166mm | 150W | AC100-277V | 120-130lm/W | 4000K-5000K | ≥80 | 60°90°120° | UGR<25 | Lumileds3030 |
| AL-HB04R-185W | Φ300*166mm | 185W | AC100-277V | 120-130lm/W | 4000K-5000K | ≥80 | 60°90°120° | UGR<25 | Lumileds3030 |
| AL-HB04R-200W | Φ300*166mm | 200W | AC100-277V | 120-130lm/W | 4000K-5000K | ≥80 | 60°90°120° | UGR<25 | Lumileds3030 |



Philips Sosen Meanwell

■ **Details:**



Linkable by Two



Foldable Power supply



Adjustable bracket for one lamp



Connector



PC-Reflector UFO



Alum Reflector

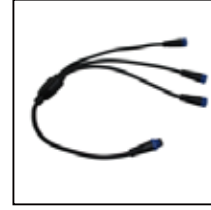

3 in one cable



Microwave sensor

■ **Thermal Image:**

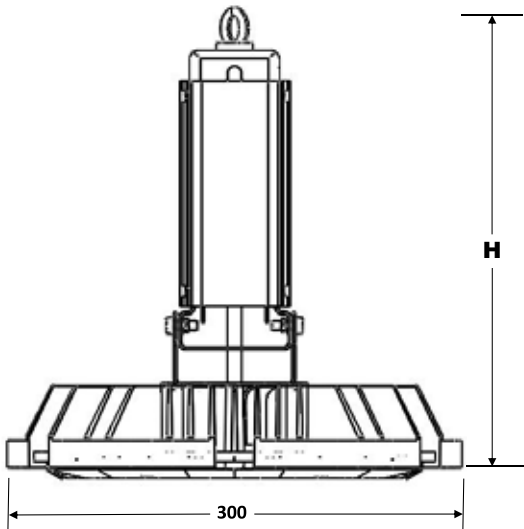

■ **Beam Angle:**

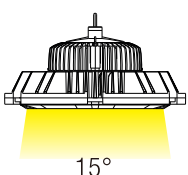

15°

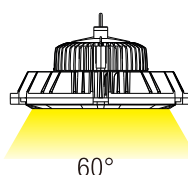

60°

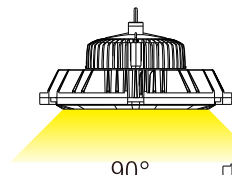

90°

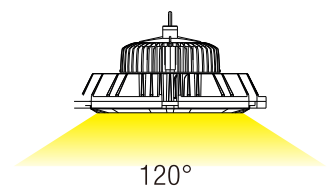

120°

Luminous Intensity Distribution:

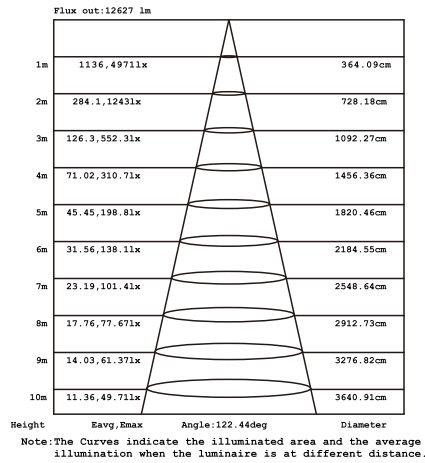
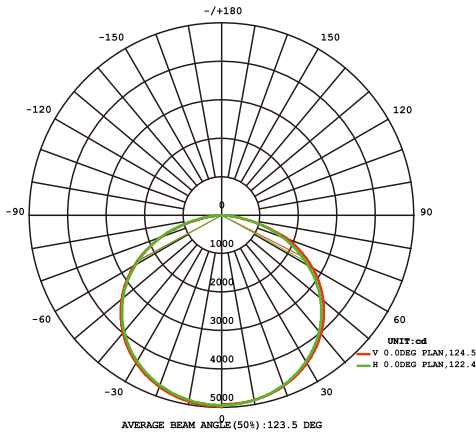

Installation diagram



- 1) drill the hole in the corresponding size on the ceiling and insert the hook into the hole.
- 2) take the assembled UFO, and put them in the hooks so that they can be placed smoothly.
- 3) in the wiring, pay special attention to distinguish between FireWire and zero line, brown as the firewire, blue is zero line, yellow green is the ground wire, and the final installation is completed

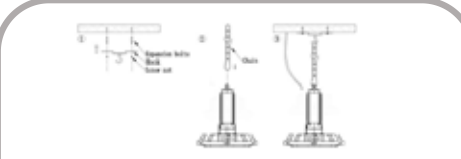

- 1) drill the hole in the corresponding size on the ceiling, Insert the expansion bolt into the hole and secure the hook to the ceiling with the nut;
- 2) as shown in Figure 2, hold the rings on the UFO;
- 3) as shown in Figure 3, Secure the other side ring of the chain carefully on the hook;
- 4) When connecting the earth wiring, pay special attention to

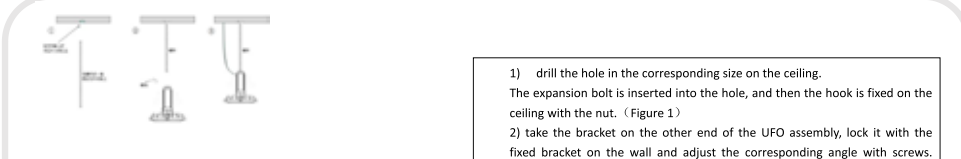

- 1) drill the hole in the corresponding size on the ceiling. The expansion bolt is inserted into the hole, and then the hook is fixed on the ceiling with the nut. (Figure 1)
- 2) take the bracket on the other end of the UFO assembly, lock it with the fixed bracket on the wall and adjust the corresponding angle with screws. (Figure 2)
- 3) When connecting the earth wiring, pay special attention to distinguish between FireWire and zero line, brown as the firewire, blue is zero line, yellow green is the ground wire, and the final installation is completed.

Package Details:

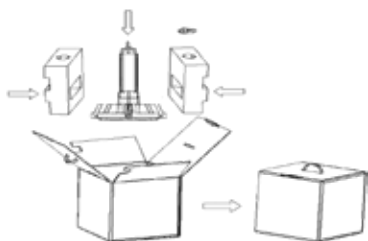

Carton size: 420*310*230mm
 Gross weight: 5.31KG



Storage environment

- Operating temperature: -20 ℃ --- +40 ℃
- Storage temperature: -25 ℃ --- +65 ℃
- Environmental level: dry, ventilated and humid environment.